

Exploded Spare Parts RSV150

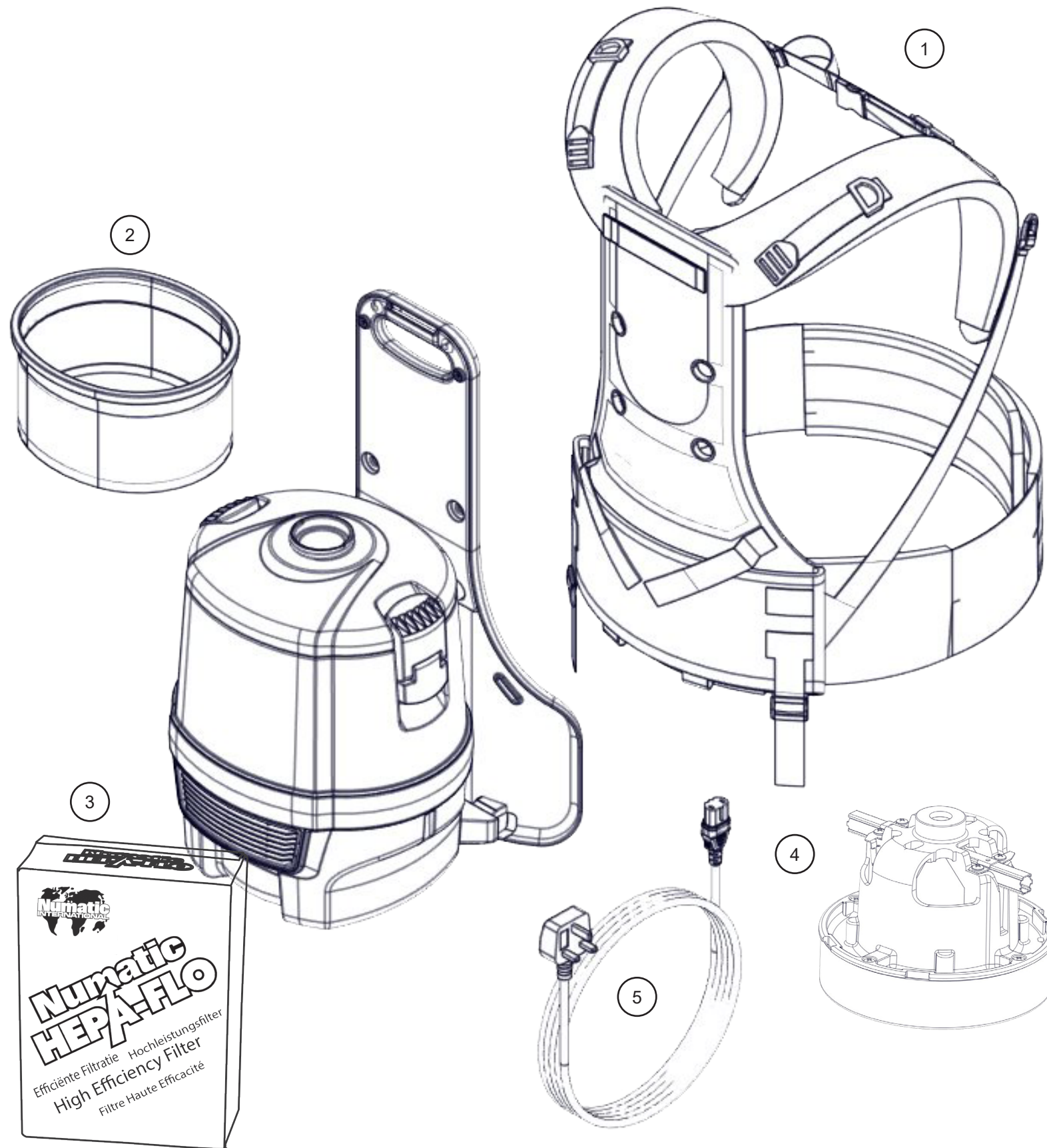

Num	Description		Num		
1	RUCKSACK HARNESS - RSB150/RSV150 (RED)		912533		
2	SHORT BACKPACK TRITEX FILTER		910915		
3	NVM-1AH INDIVIDUAL HEPAFLO FILTER BAG (RSV130)		604018		
4	230V SINGLE STAGE TF MOTOR (DLI 653T) TCO (6210820147)		908947		
5	15MT X 1MM X 2CORE CABLE UK PLUG	910610	5	15MT X 1MM X 2CORE CABLE YELLOW AUS+NZ PLUG	910477
5	15MT X 1MM X 2CORE CABLE EURO PLUG YELLOW JACKET	911347	5	15MT X 1MM X 2CORE CABLE RSA PLUG YELLOW JACKET	910481
5	15MT X 1MM X 2CORE CABLE SWISS PLUG YELLOW JACKET	911346	5	CSA/USA 10A.2PIN PLUG SJT (105 DEG) 2 X 18AWG.15M.22205 YELLOW	912333

Genuine Accessories (Kit AAT30E(270))

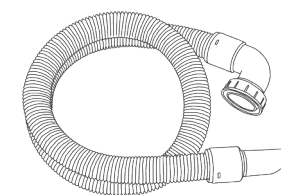

913003 RSV/RSB Threaded Hose

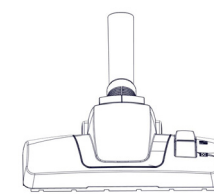

902923 (270)
Combination Floor Tool



914759 Ali Telescopic Wand

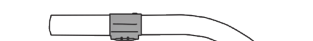

601214 Ali BLK Wand

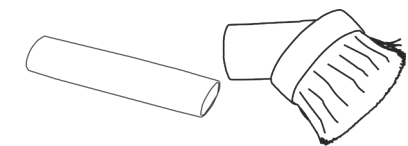

909564 Handy Kit



Numatic International Limited, Chard, Somerset, TA20 2GB
Telephone: 01460 68600
Fax: 01460 68458

UNITED KINGDOM: www.numatic.co.uk
NETHERLANDS: www.numatic.nl
PORTUGAL: www.numatic.pt

GERMANY: www.numatic.de
SWITZERLAND: www.numatic.ch
SPAIN: www.numatic.es

FRANCE: www.numatic.fr
SOUTH AFRICA: www.numatic.co.za

www.numatic.co.uk

Specification subject to change without prior notice
www.numatic.co.uk © Numatic International Limited

MED-000933 02/22 (A02)